

4G Small Stick Antenna

FEATURES



- Mini 4GHz PCB Antenna



The Feasycom F12E00062A0、 F12E00062A1 range of antennas are designed to decrease the lifetime cost of M2M and mobile device installations by offering a robust, effective antenna that is easy to install and lasts the lifetime of the installation without the need for maintenance.

PRODUCTS

Part No.	Weight	Dimensions (L x W x H)	Connector	Color
(M02-0500730R0A) F12E00062A0	12.2g	Φ13*134mm	SMA MACHO	Black
(M02-0500740R0A) F12E00062A1	12.2g	Φ13*134mm	RP-SMA MALE	Black

SPECIFICATIONS

PARAMETER	SPECIFICATION	
Frequency Bands, MHz	824-960	1710-2690
VSWR (Max)	10.0:1	3.0:1
Peak Gain, dBi (Typ)	Up to -0.44@824-960MHz/Up to 2.58@1710-2690MHz	
Nominal Impedance	50 Ω	
Max Power (ambient temp of 25°C)	10 Watts	
Azimuth Beam Width (deg)	Omnidirectional	
Polarization	Linear	
Radome	PC, Black	
Storage Temperature Range (°C)	-40° C to +85° C	
Operational Temperature Range (°C)	-40° C to +85° C	
Material Substance Compliance	REACH/RoHS Compliant	
HSCODE	8517707090	
USHSCODE	8517620010	
UPC		

Shenzhen Feasycom Co.,LTD

ADD: Rm 508, Building A, Fenghuang Zhigu, No.50, Tiezai Road, Xixiang, Baoan District,Shenzhen,518100, China.

Tel: 86-755-27924639 E-mail: sales@feasycom.com



FEASYCOM

ELECTRICAL DATA

Return Loss

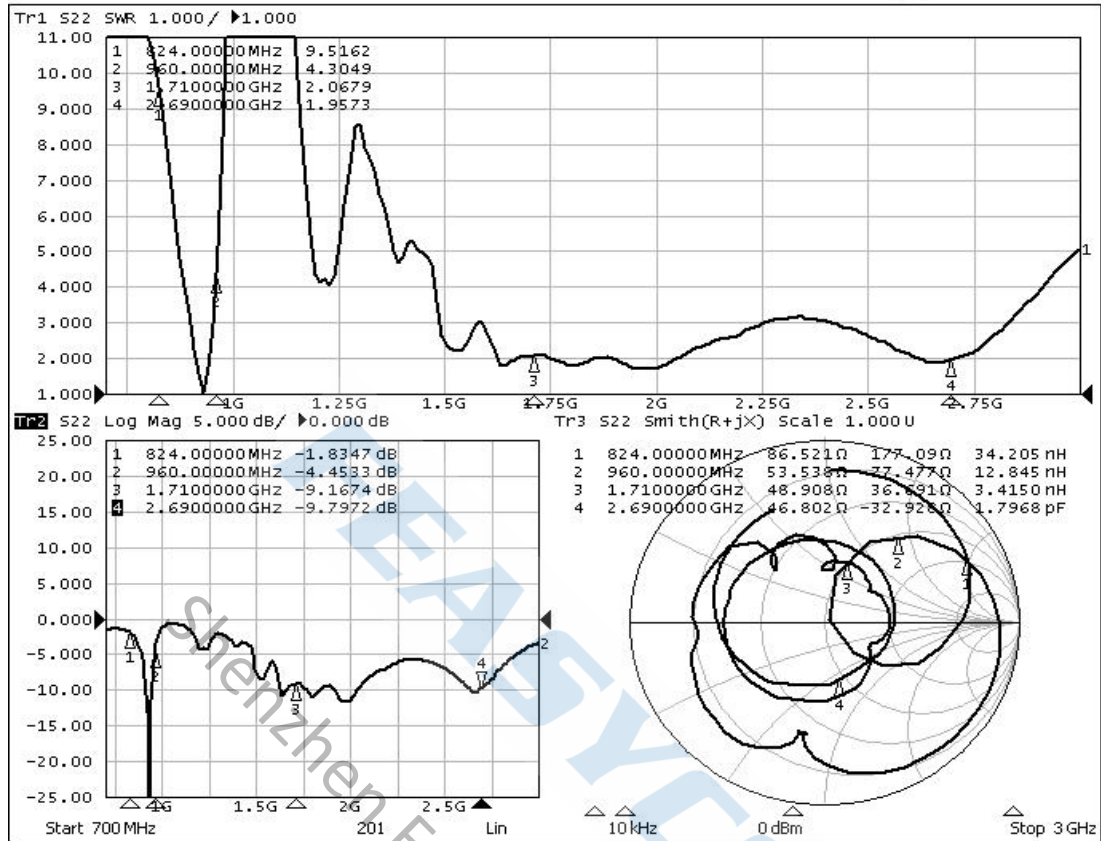

Efficiency (%)

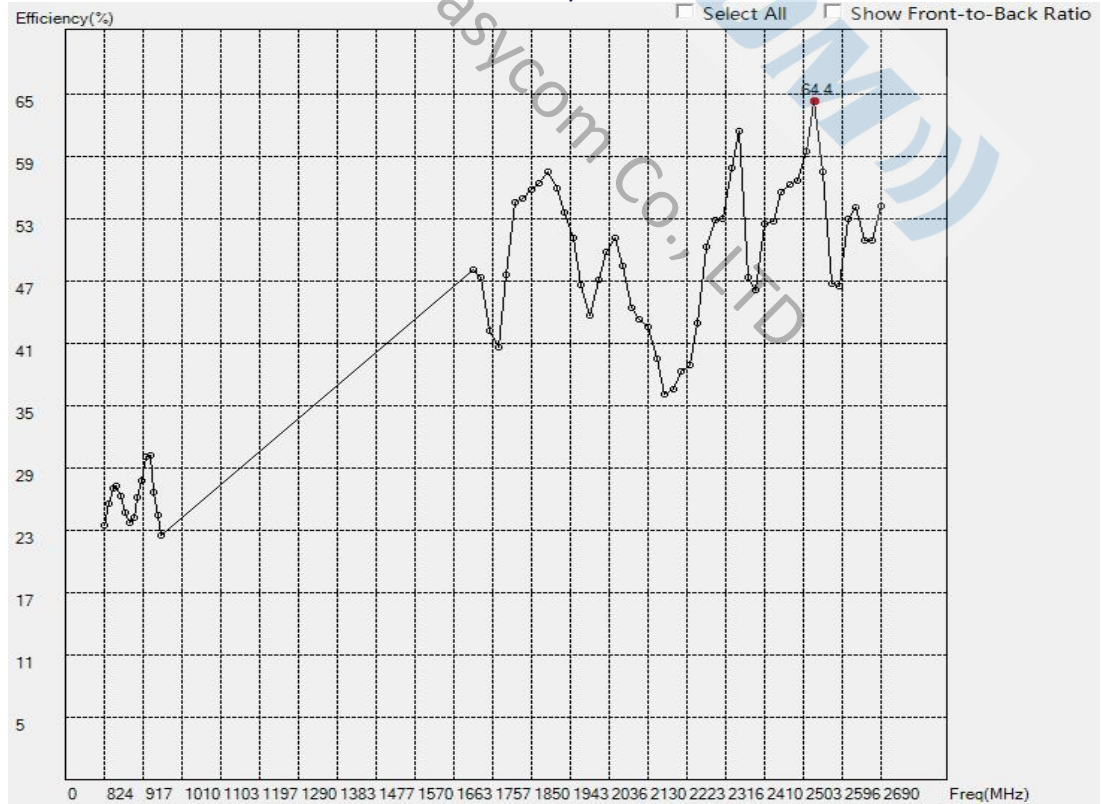

Shenzhen Feasycom Co.,LTD

ADD: Rm 508, Building A, Fenghuang Zhigu, No.50, Tiezai Road, Xixiang, Baoan District,Shenzhen,518100, China.

Tel: 86-755-27924639 E-mail: sales@feasycom.com



Peak Gain (dBi)

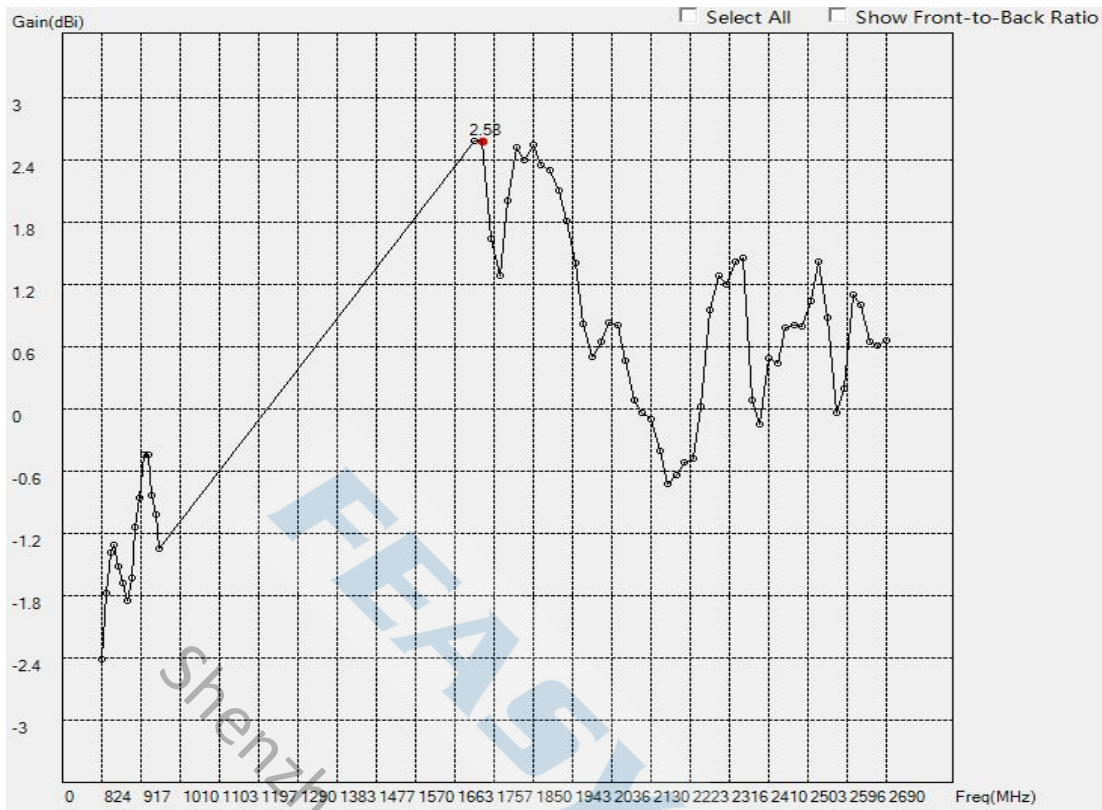

Shenzhen Feasycom Co.,LTD

ADD: Rm 508, Building A, Fenghuang Zhigu, No.50, Tiezai Road, Xixiang, Baoan District,Shenzhen,518100, China.

Tel: 86-755-27924639 E-mail: sales@feasycom.com



FEASYCOM

RADIATION PATTERNS

2D Radiation Pattern at 854MHz

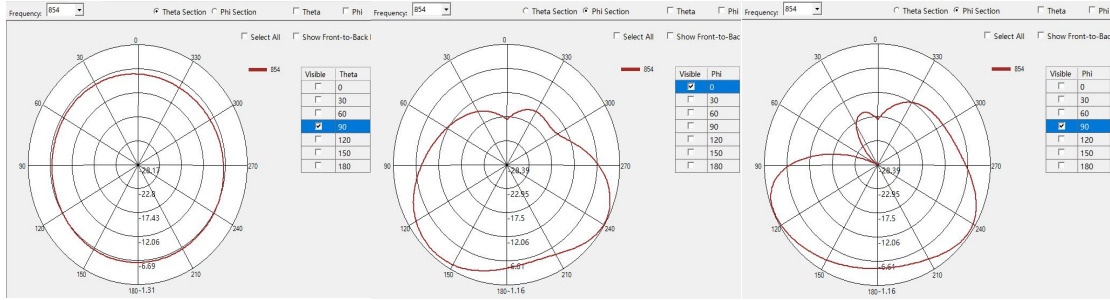

2D Radiation Pattern at 954MHz

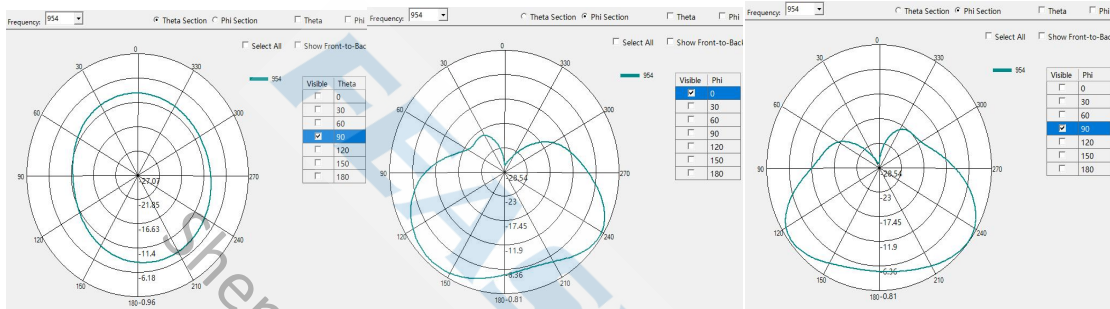

2D Radiation Pattern at 1850MHz

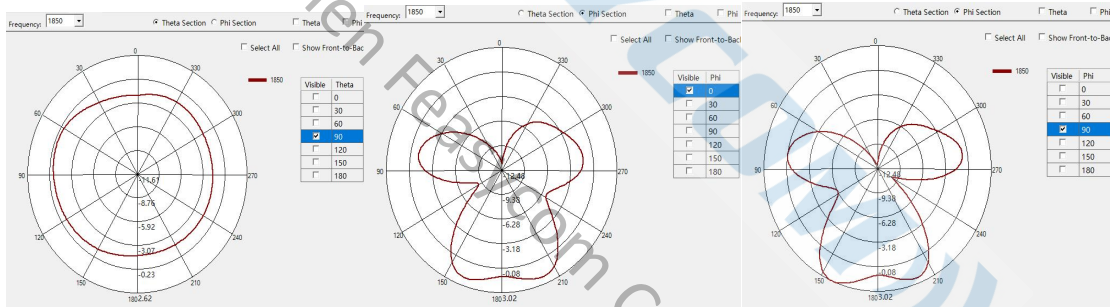

2D Radiation Pattern at 2550MHz

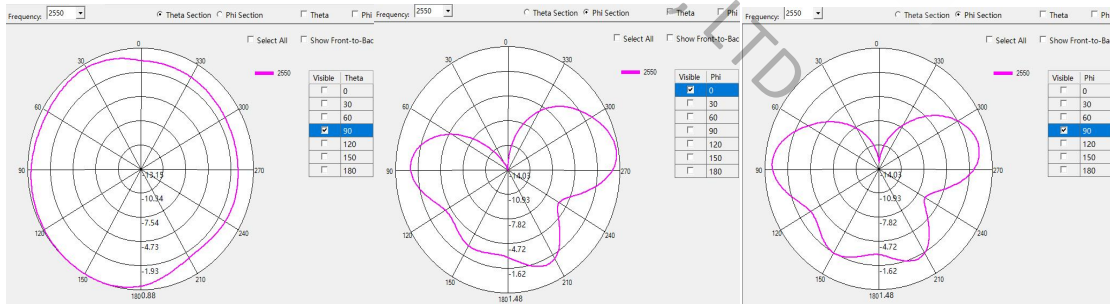

Shenzhen Feasycom Co.,LTD

ADD: Rm 508, Building A, Fenghuang Zhigu, No.50, Tiezai Road, Xixiang, Baoan District, Shenzhen, 518100, China.

Tel: 86-755-27924639 E-mail: sales@feasycom.com

HOUSING CONFIGURATIONS

