

# 40x8 WIFI 7 Antenna



## FEATURES



- 2.80 dBi Peak Gain@2.4G
- 5.46 dBi Peak Gain@5.8G
- Welding RG 1.13 cable, Ipex connector, 3M sticker for easy installation.
- For smart device wireless, Zigbee, Bluetooth terminal

## PRODUCTS

Part No.	Weight	Dimensions (L x WxH)	Cables Dimensions	Connector	Color
(M01-0201280R0A) F12E00061A0	0.5	FPC:40.0*8.0*0.2 mm	Φ1.13*110mm	IPEX1	Black

## SPECIFICATIONS

PARAMETER	SPECIFICATION	
Frequency Bands, MHz	2400-2500	4900-7200
VSWR (Max)	1.6:1	2.2:1
Peak Gain, dBi (Typ)	Up to 2.89 dBi@2.4G/Up to 5.46 dBi@5.8G	
Nominal Impedance	50 Ω	
Max Power (ambient temp of 25°C)	10 Watts	
Azimuth Beam Width (deg)	60°	
Polarization	Linear	
Color	Black	
Storage Temperature Range (°C)	-40° C to +85° C	
Operational Temperature Range (°C)	-40° C to +85° C	
Material Substance Compliance	REACH/RoHS Compliant	

Shenzhen Feasycom Co.,LTD

ADD: Rm 508, Building A, Fenghuang Zhigu, No.50, Tiezai Road, Xixiang, Baoan District, Shenzhen, 518100, China.

Tel: 86-755-27924639 E-mail: [sales@feasycom.com](mailto:sales@feasycom.com)



FEASYCOM

## ELECTRICAL DATA

### Return Loss

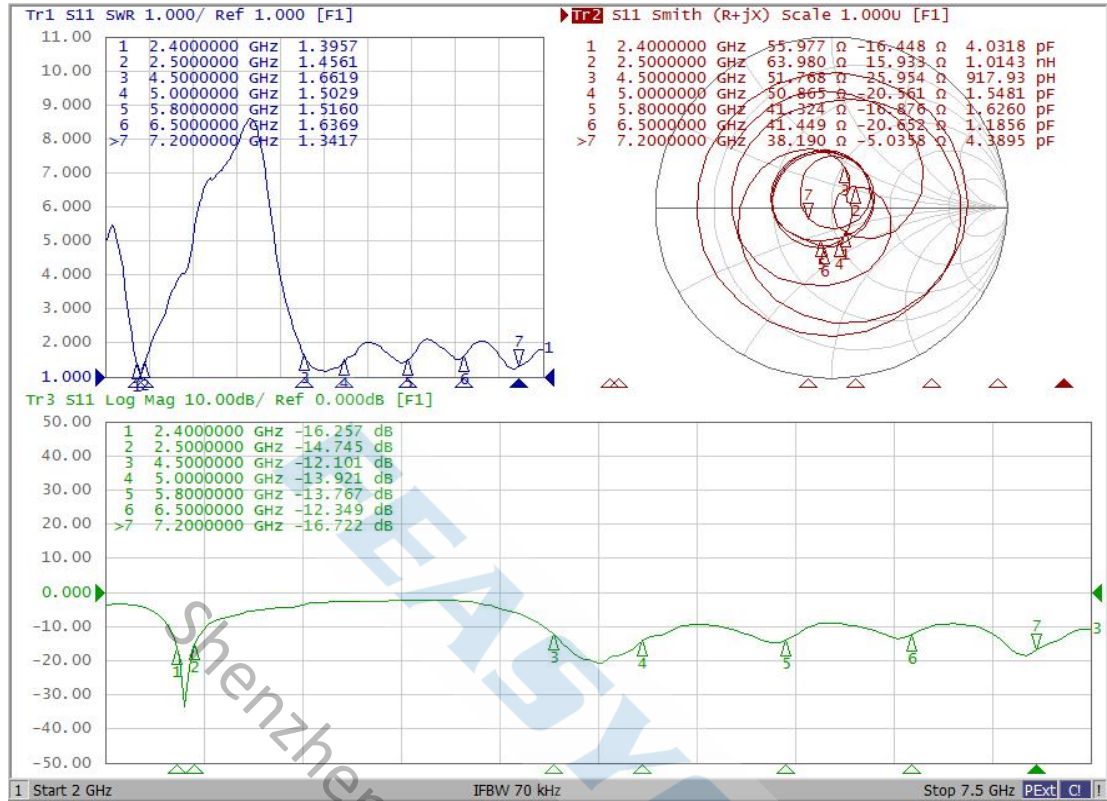

### Efficiency (%)

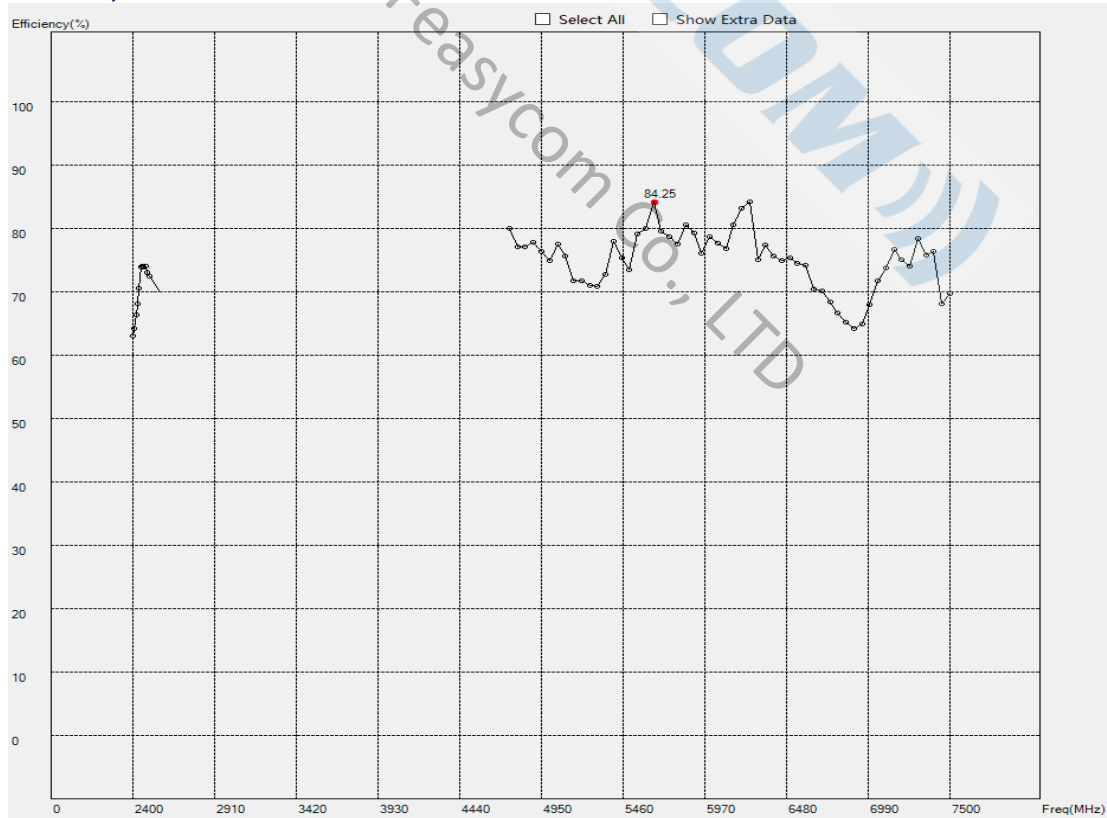

Shenzhen Feasycom Co.,LTD

ADD: Rm 508, Building A, Fenghuang Zhigu, No.50, Tiezai Road, Xixiang, Baoan District, Shenzhen, 518100, China.

Tel: 86-755-27924639 E-mail: [sales@feasycom.com](mailto:sales@feasycom.com)



FEASYCOM

## Peak Gain (dBi)



## RADIATION PATTERNS

Radiation pattern reference

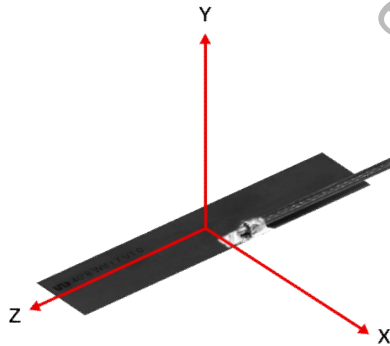

## 2D Radiation Pattern at 2410MHz/2450MHz/2490MHz

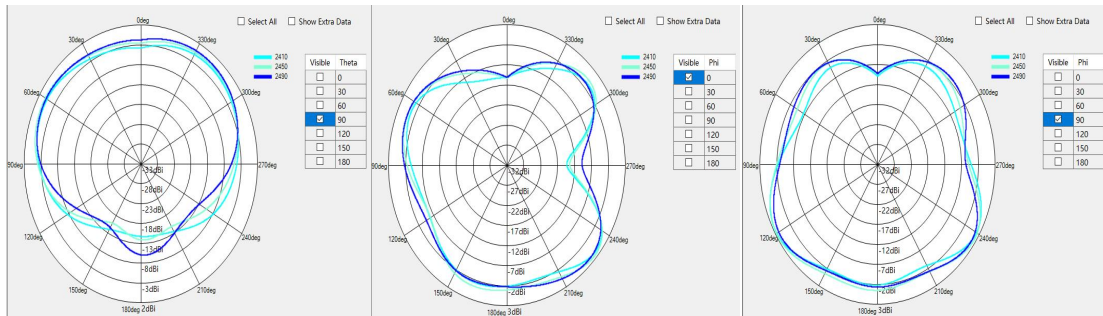

Shenzhen Feasycom Co.,LTD

ADD: Rm 508, Building A, Fenghuang Zhigu, No.50, Tiezai Road, Xixiang, Baoan District, Shenzhen, 518100, China.

Tel: 86-755-27924639 E-mail: [sales@feasycom.com](mailto:sales@feasycom.com)

### 2D Radiation Pattern at 4900MHz/5550MHz/5900MHz

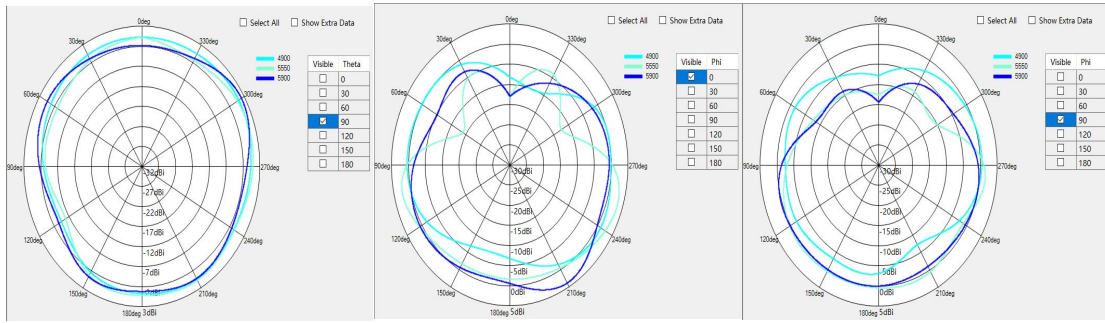

### 2D Radiation Pattern at 6100MHz/6500MHz/7100MHz

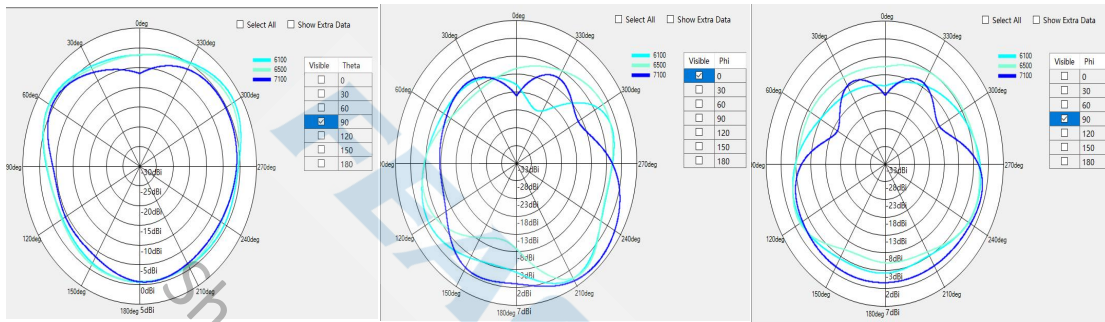

### 3D Radiation Pattern at 2450MHz Gain=2.8 dBi

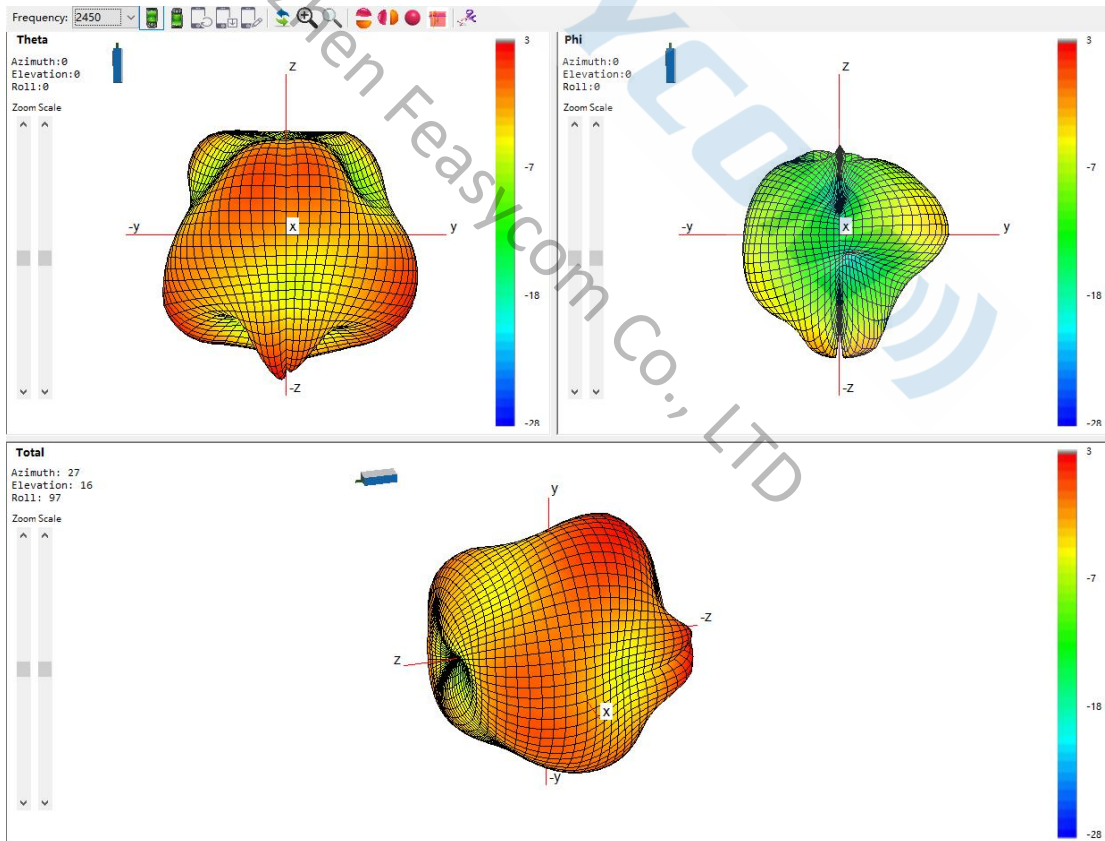

### 3D Radiation Pattern at 5500MHz Gain=3.59 dBi

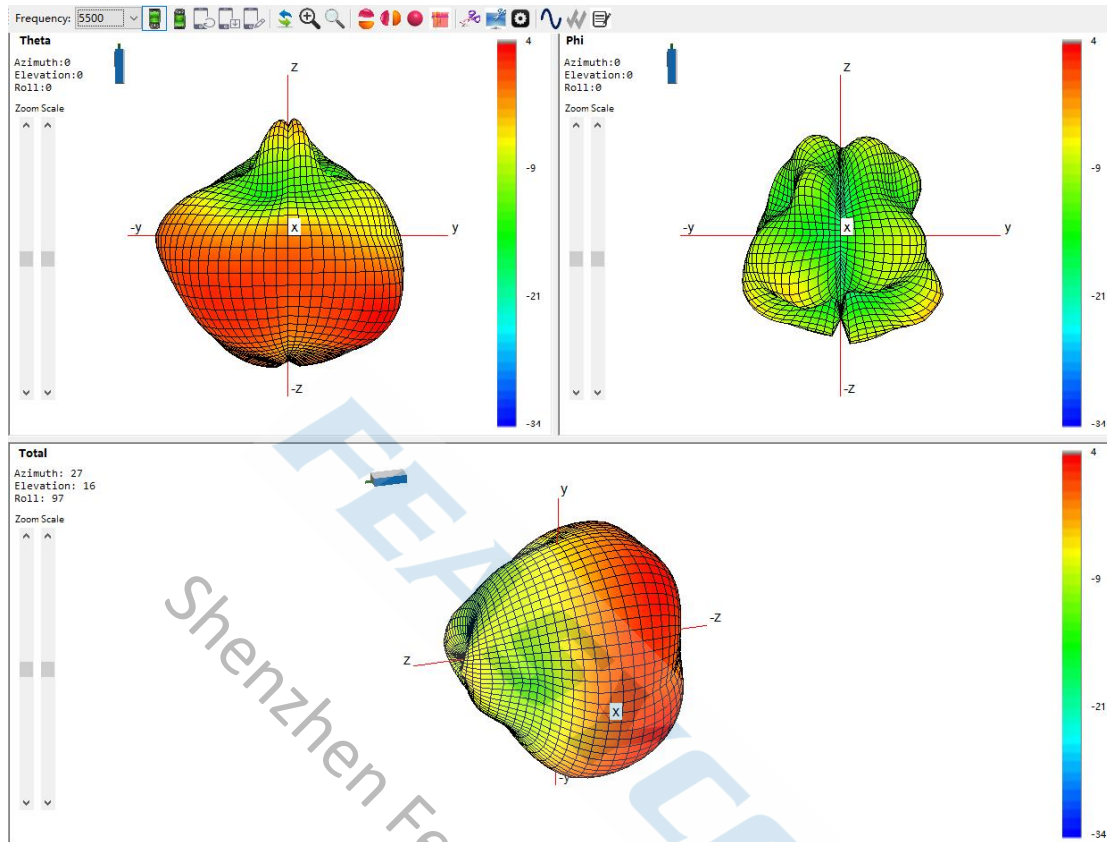

### 3D Radiation Pattern at 6500MHz Gain=4.39 dBi

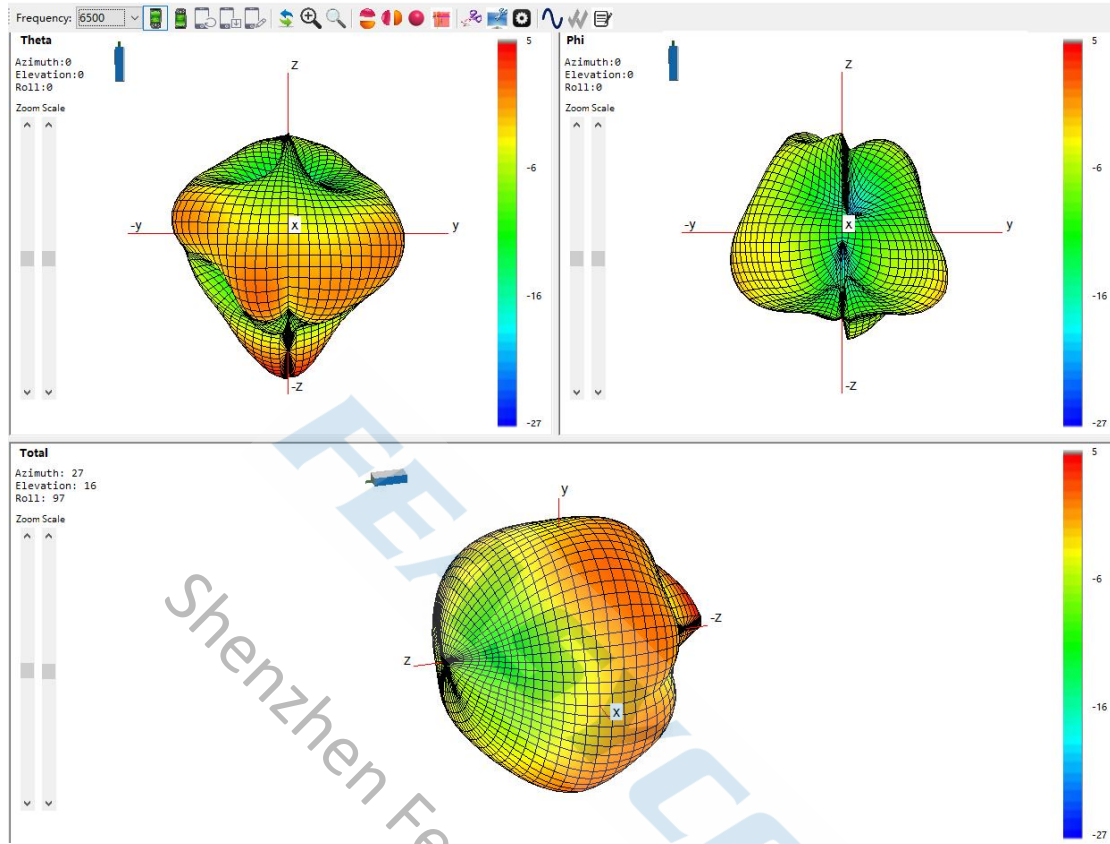



FEASYCOM

## HOUSING CONFIGURATIONS

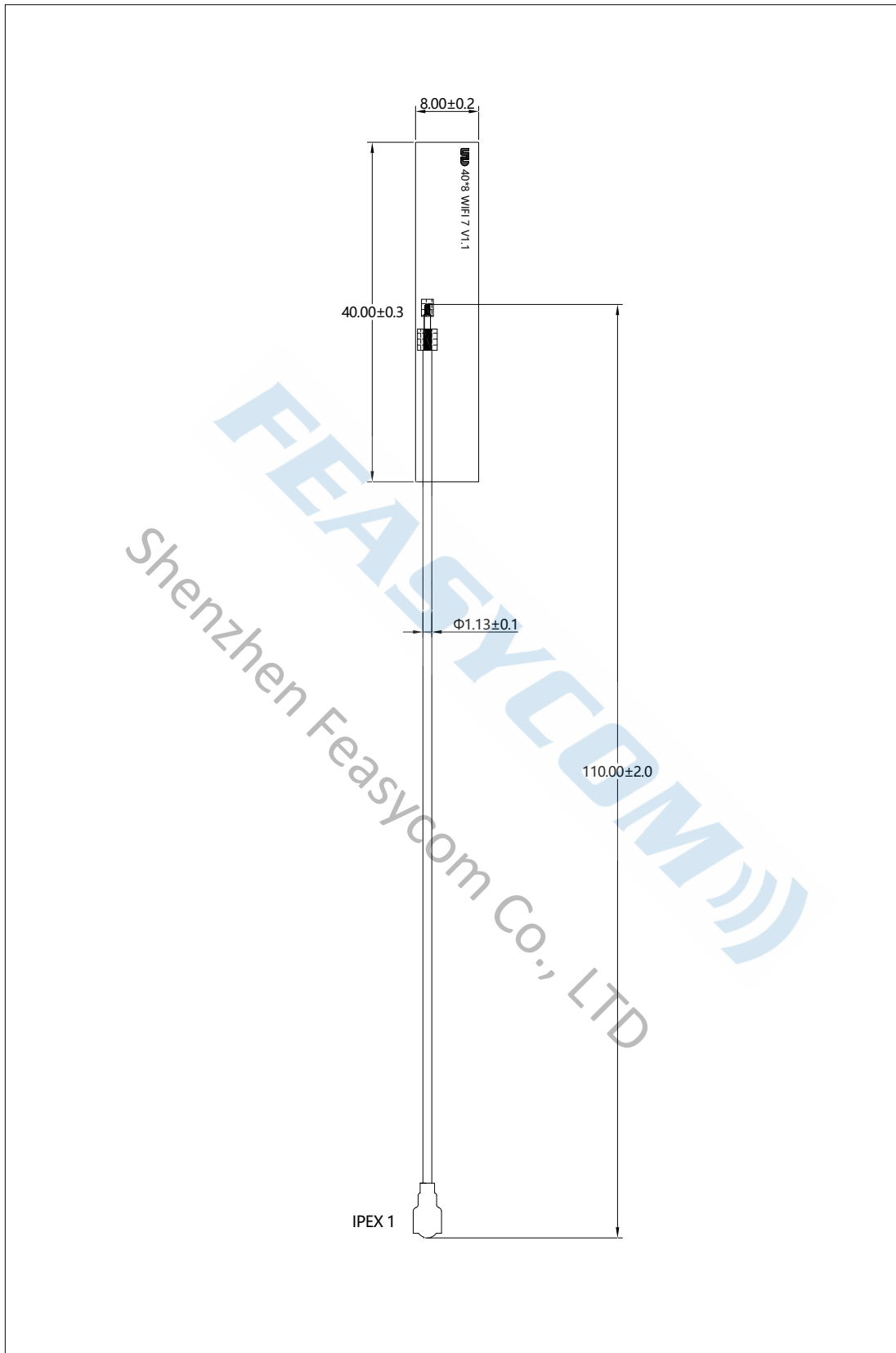

Shenzhen Feasycom Co.,LTD

ADD: Rm 508, Building A, Fenghuang Zhigu, No.50, Tiezai Road, Xixiang, Baoan District,Shenzhen,518100, China.

Tel: 86-755-27924639 E-mail: [sales@feasycom.com](mailto:sales@feasycom.com)